

Model 41A6408 Absolute Encoder System

1. Disconnect power.
2. Using a 1/4" socket head or Phillips screwdriver, remove the two screws located at the bottom of the opener, securing the cover (Figure 1).
3. Remove cover (Figure 2).
4. Disconnect 5-wire connector from the absolute encoder system (Figure 3).
5. Remove the two screws securing the absolute encoder system to the opener (Figure 3).
6. Slide or shift the absolute encoder system towards the front of the unit and pull out (Figure 4).
7. Align the mounting tabs to the side panel. Push in the absolute encoder system.
8. Secure absolute encoder with screws.
9. Reconnect 5-wire connector.
10. Replace cover and reconnect power.
11. Refer to the owner's manual for information on programming instructions for travel limits, setting forces, and testing the Protector System®. Refer to the owner's manual for information on the cable tension monitor and power door lock.

WARNING

To prevent possible **SERIOUS INJURY** or **DEATH** from electrocution, disconnect power to opener **BEFORE** proceeding.

Figure 1

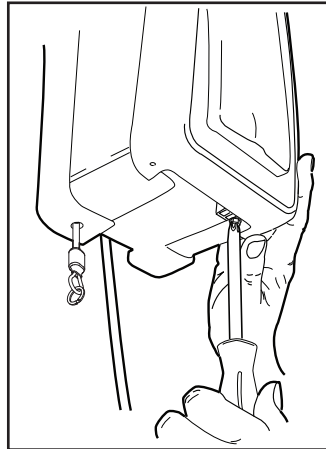

Figure 2

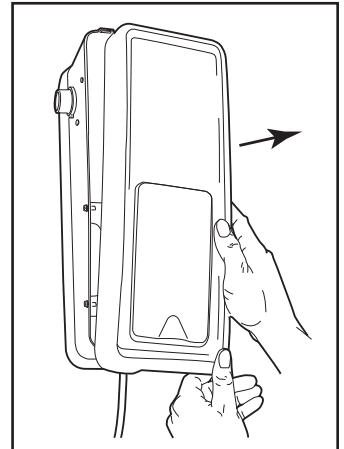

Figure 3

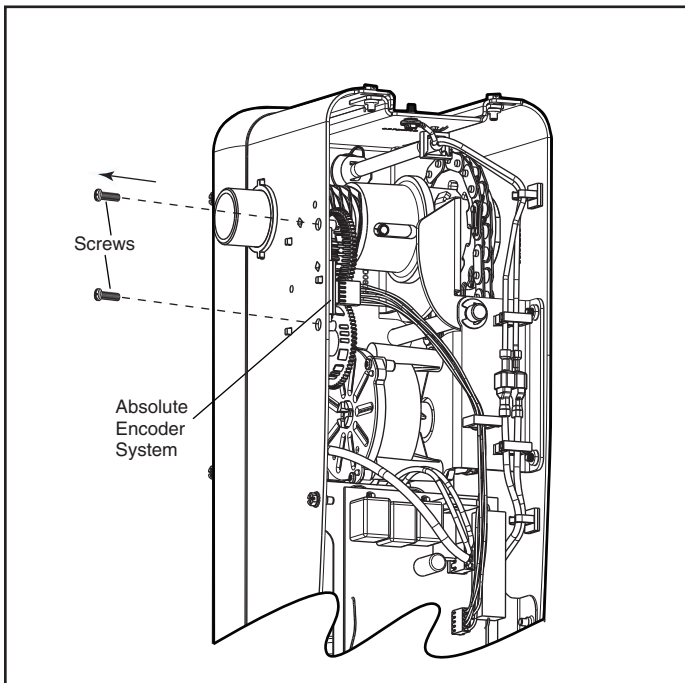
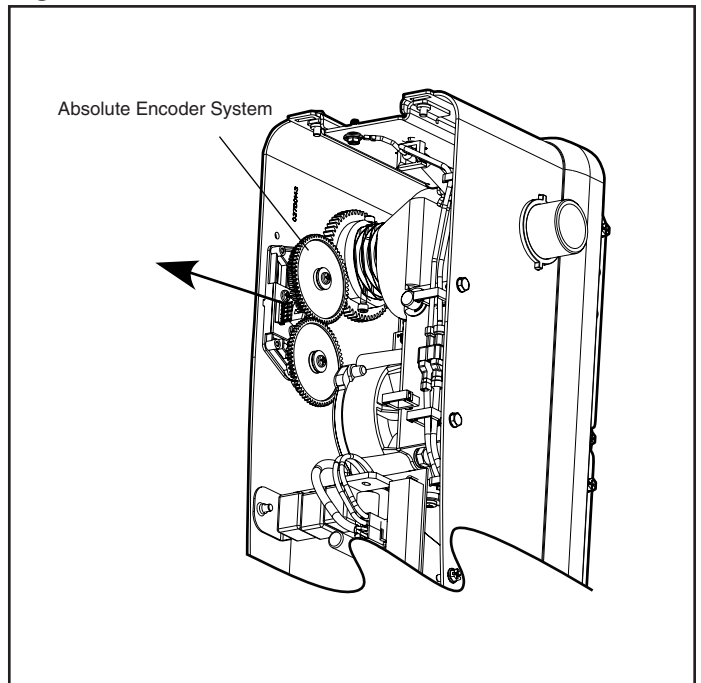

Figure 4



PROGRAMMING

NOTICE: If this Security+® garage door opener is operated with a non-rolling code transmitter, the technical measure in the receiver of the garage door opener, which provides security against code-theft devices, will be circumvented. The owner of the copyright in the garage door opener does not authorize the purchaser or supplier of the non-rolling code transmitter to circumvent that technical measure.

Your garage door opener has already been programmed at the factory to operate with your hand-held remote control. The door will open and close when you press the large push button.

Below are instructions for programming your opener to operate with additional Security+® remote controls.

To Add or Reprogram a Hand-held Remote Control

USING THE "LEARN" BUTTON

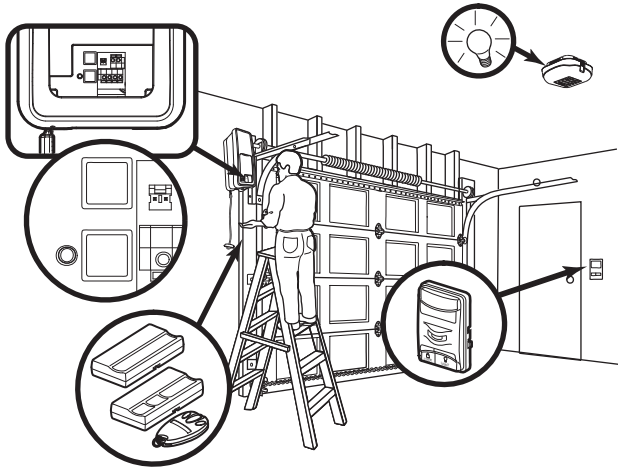

1. Press and release the purple "learn" button on the motor unit. The learn indicator light will glow steadily for 30 seconds.

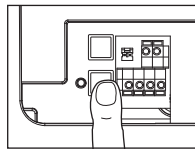

2. Within 30 seconds, press and hold the button on the hand-held remote* that you wish to operate your garage door.

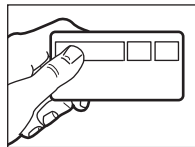

3. Release the button when the motor unit lights blink. It has learned the code. If light bulbs are not installed, two clicks will be heard.

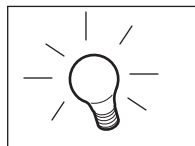

Reprogramming Light or Additional Light

Your garage door opener remote work light has already been programmed at the factory to operate with your opener. Any additional or replacement remote work lights will need to be programmed.



1. Press the "learn button" on light until LED comes ON.

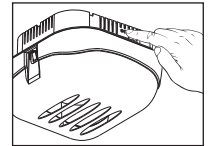

2. Activate the garage door using the hand-held remote, wall control or keyless entry.

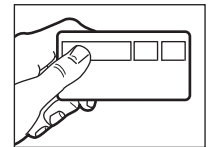

3. It has learned the code and the light turns on.

NOTICE: To comply with FCC and or Industry Canada (IC) rules, adjustment or modifications of this receiver and/or remote control are prohibited, except for changing the code setting or replacing the battery. THERE ARE NO OTHER USER SERVICEABLE PARTS.

Tested to Comply with FCC Standards FOR HOME OR OFFICE USE. Operation is subject to the following two conditions: (1) this device may not cause harmful interference, and (2) this device must accept any interference received, including interference that may cause undesired operation.

To Erase All Codes From Motor Unit Memory

To deactivate any unwanted remote, first erase all codes:

Press and hold the "learn" button on motor unit until the learn indicator light goes out (approximately 6-9 seconds). All previous codes are now erased. Reprogram each remote or keyless entry you wish to use.

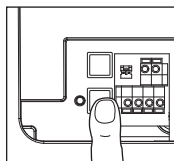

*3-Button Remote

If provided with your garage door opener, the large button is factory programmed to operate it. Additional buttons on any Security+® 3-Button remote or mini-remote can be programmed to operate other Security+® garage door openers.

